

RUMBLESTONE®

OUTDOOR KITCHEN DESIGNS - ASHLAR

Large or small, elegant or rustic, Pavestone offers a variety of options to serve as a backyard focal point. You can create an expanded living area that will serve as a favorite gathering spot for years to come.

RUMBLESTONE® OUTDOOR KITCHEN DESIGNS

The RumbleStone system includes a set of rustic building blocks for your outdoor hardscape projects. The weathered appearance offers a natural look and feel, adding texture and depth to both vertical and paving applications. RumbleStone can be assembled in an infinite variety of configurations and orientations. Increase the possibilities for creative expression in your backyard landscape using RumbleStone and enjoy its beauty, versatility and strength.

RUMBLESTONE BLOCKS:



	Width (in)	Length (in)	Height (in)
Mini	3.5	7	1.75
Medium	7	7	3.5
Large	10.5	7	3.5

MODULES:

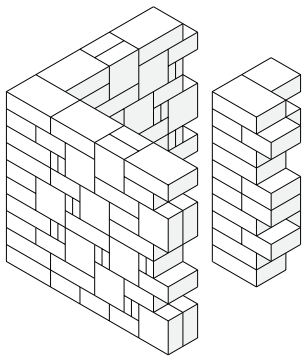

CORNER MODULE

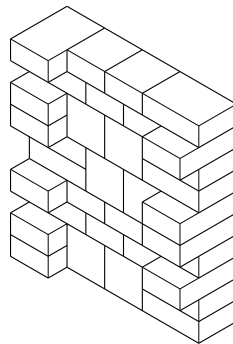

END MODULE

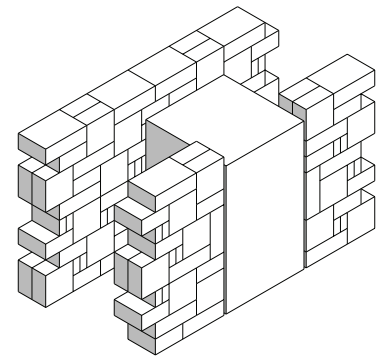

FRIDGE MODULE

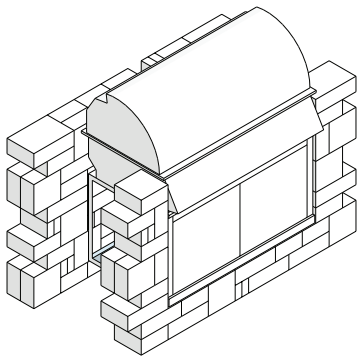

38.5 INCH GRILL MODULE

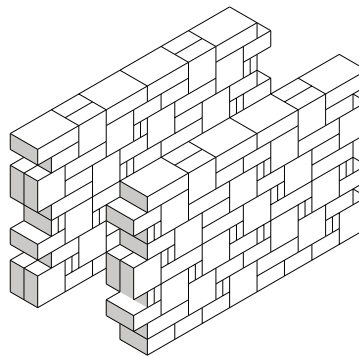

STRAIGHT MODULE

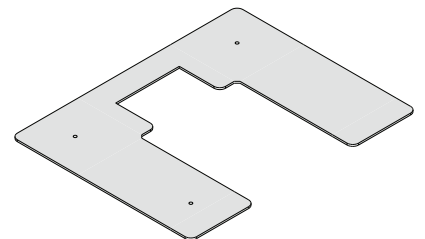

Contact a counter top manufacturer to add custom counter tops to your RumbleStone® Kitchen Project.

By combining different modules, you can create your
Dream Outdoor Kitchen

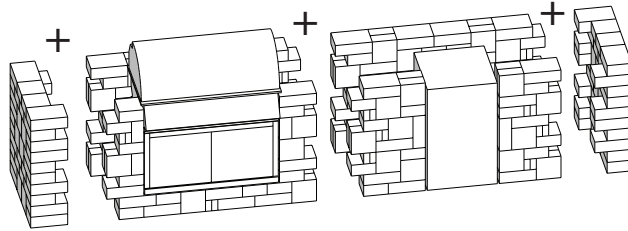

**ASHLAR
PROJECT IDEAS:**

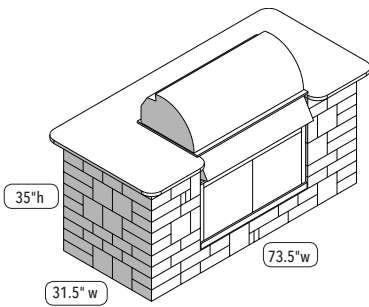

(2) END MODULES
(1) GRILL MODULE

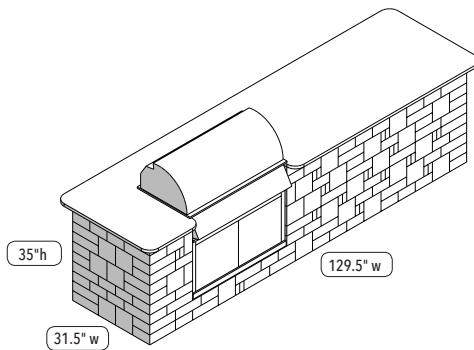

(2) END MODULES
(1) GRILL MODULE
(1) STRAIGHT MODULE

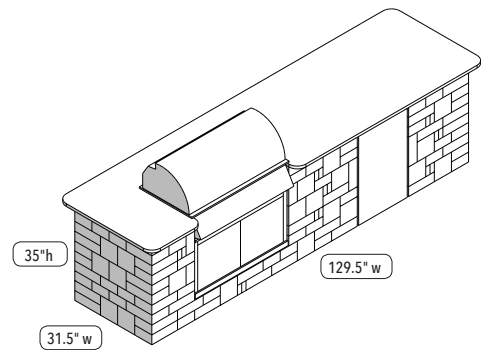

(2) END MODULES
(1) GRILL MODULE
(1) FRIDGE MODULE

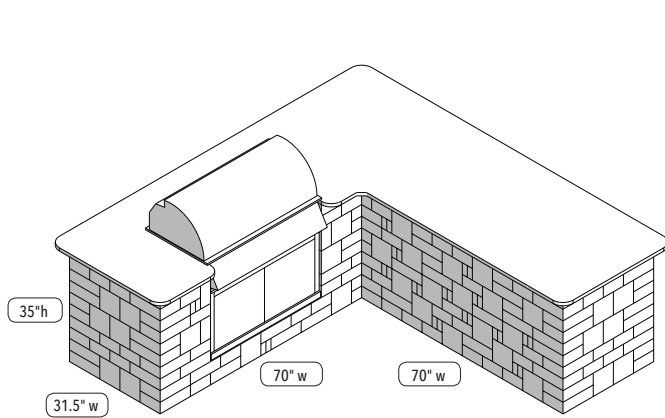

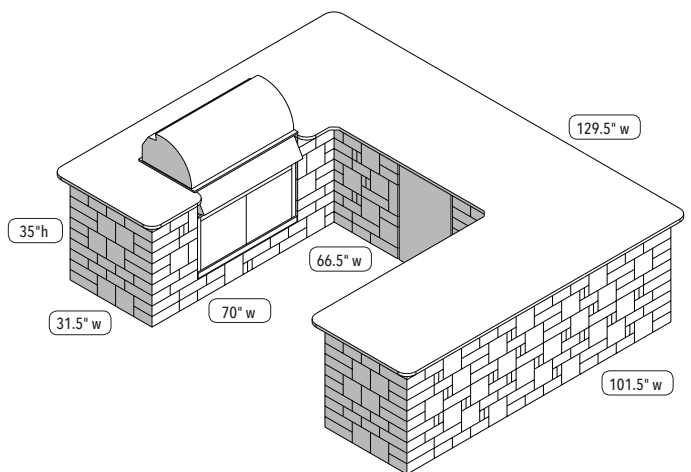

(2) END MODULES
(1) CORNER MODULE
(1) GRILL MODULE
(1) STRAIGHT MODULE



(2) END MODULES
(2) CORNER MODULES
(1) GRILL MODULE
(1) FRIDGE MODULE
(1) STRAIGHT MODULE

INSTALLATION INSTRUCTIONS

Corner Module

NUMBER OF PIECES PER PROJECT:			HOME DEPOT SKU#		
			Café	Sierra Blend	GreyStone
	Mini	24	163156	397745	164917
	Medium	66	165955	397681	166379
	Large	32	166606	396781	166804

- Prepare stable, level project area.
- Stack stones, adding construction adhesive between layers.

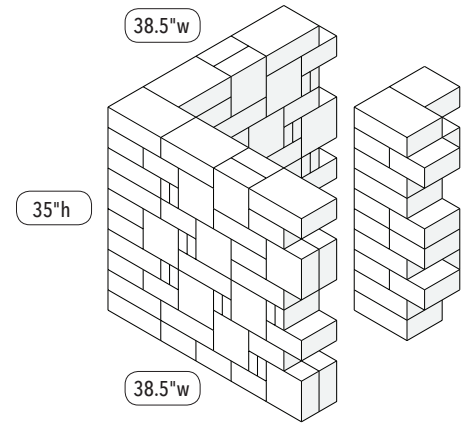

Measurements for projects are approximate.

Step 1

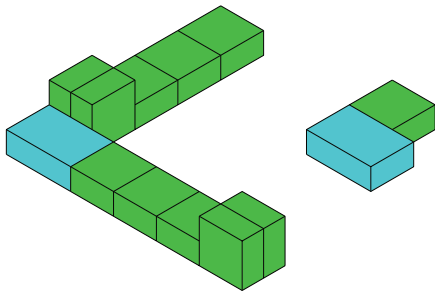

Step 2

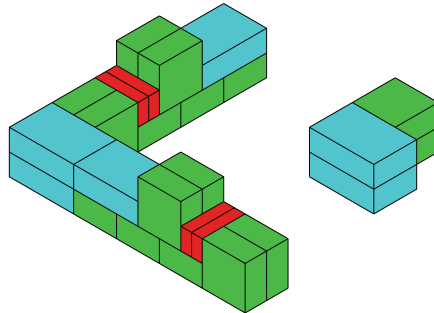

Step 3

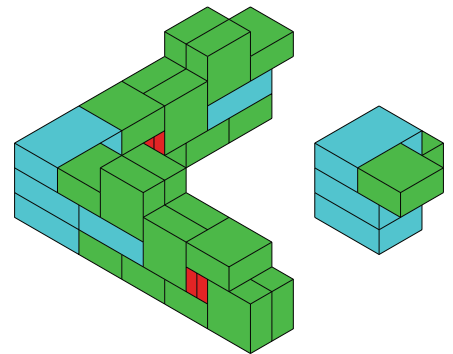

Step 4

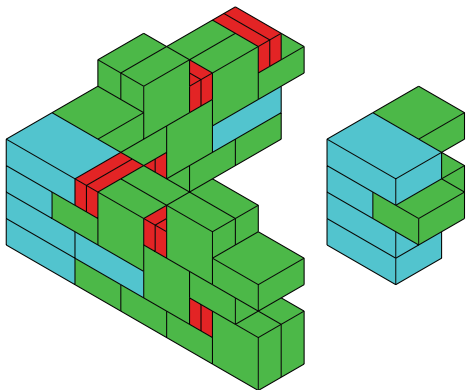

Step 5

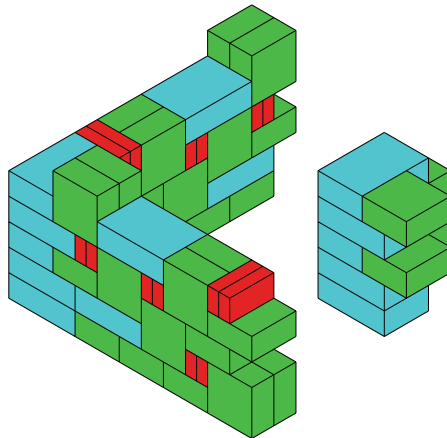

Step 6

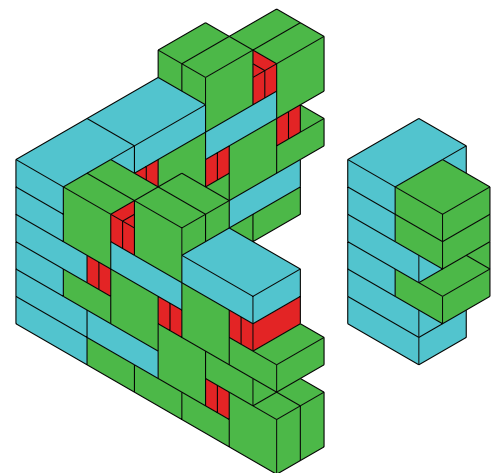

Step 7

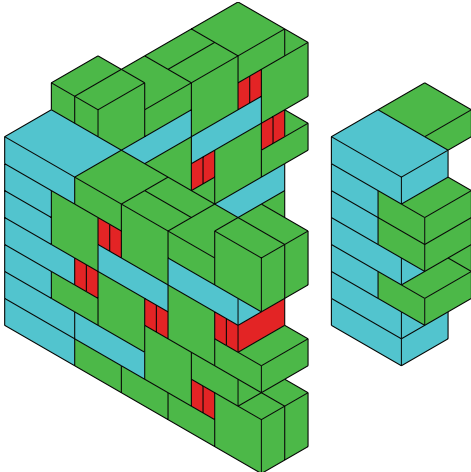

Step 8

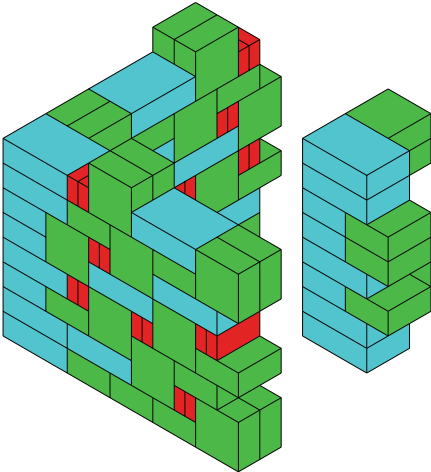

Step 9

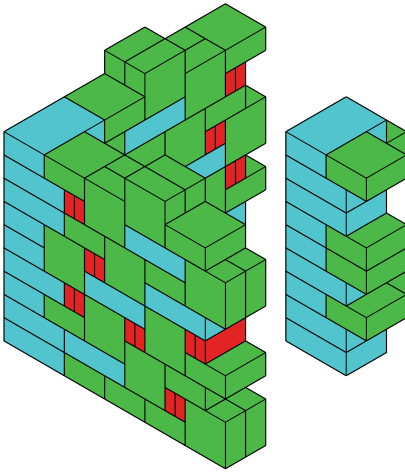

Step 10

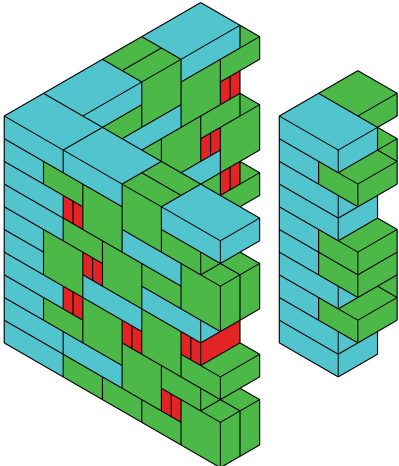

INSTALLATION INSTRUCTIONS

End Module

NUMBER OF PIECES PER PROJECT:			HOME DEPOT SKU#		
			Café	Sierra Blend	GreyStone
Medium	20	165955	397681	166379	
Large	20	166606	396781	166804	

- Prepare stable, level project area.
- Stack stones, adding construction adhesive between layers.

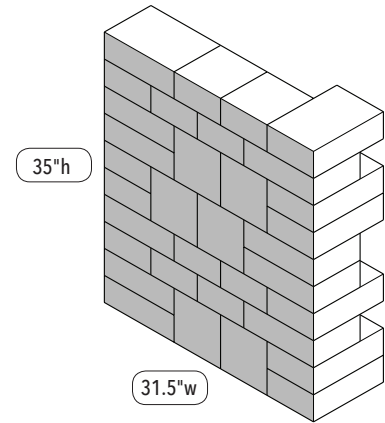

Measurements for projects are approximate.

Step 1

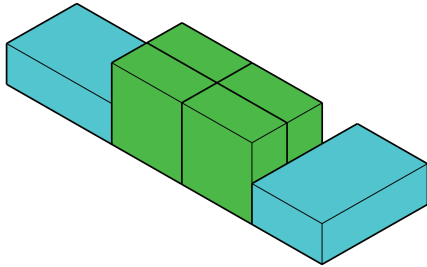

Step 2

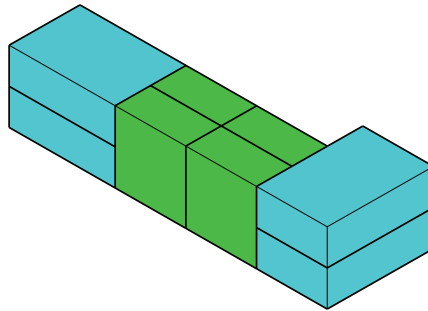

Step 3

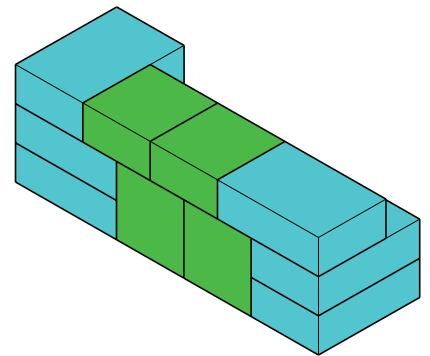

Step 4

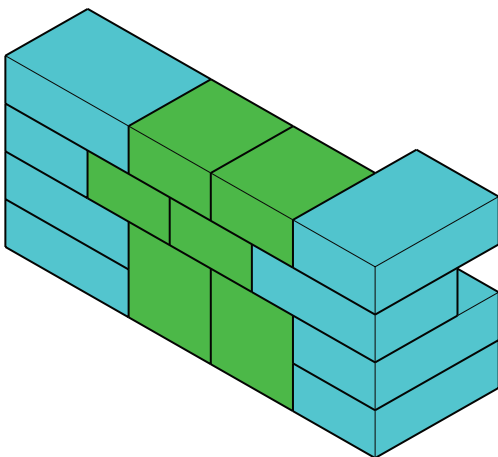

Step 5

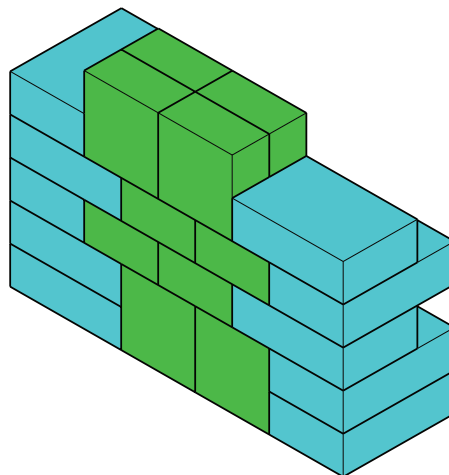

Step 6

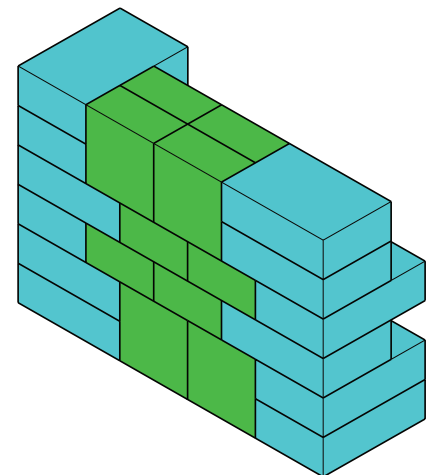

Step 7

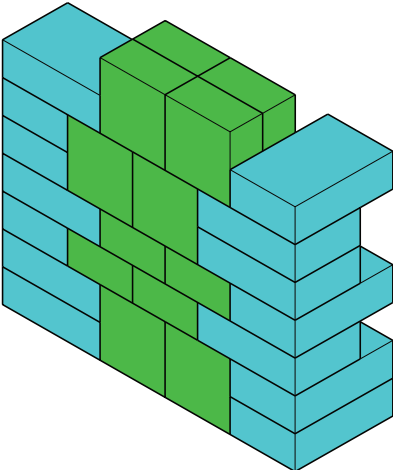

Step 8

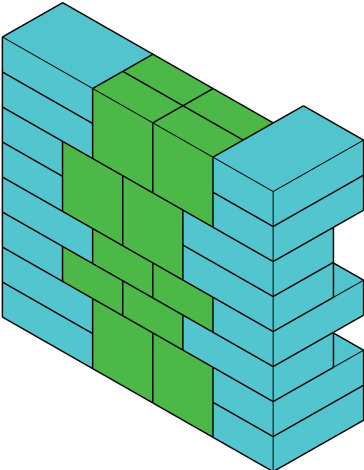

Step 9

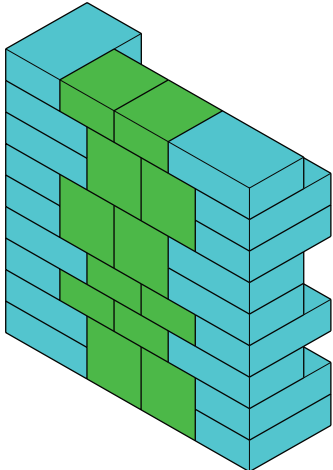

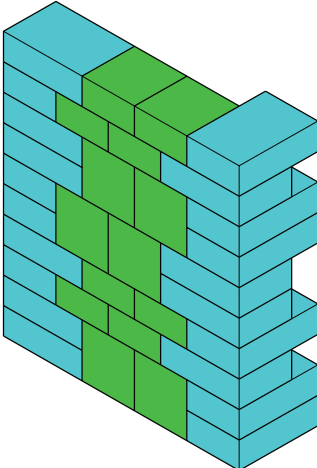

Step 10



INSTALLATION INSTRUCTIONS

Straight Module

NUMBER OF PIECES PER PROJECT:			HOME DEPOT SKU#		
			Café	Sierra Blend	GreyStone
	Mini	48	163156	397745	164917
	Medium	112	165955	397681	166379
	Large	24	166606	396781	166804

- Prepare stable, level project area.
- Stack stones, adding construction adhesive between layers.

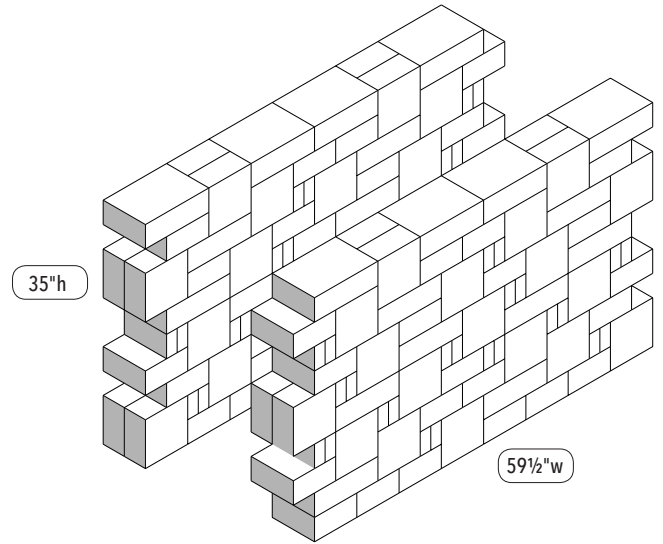

Measurements for projects are approximate.

Step 1

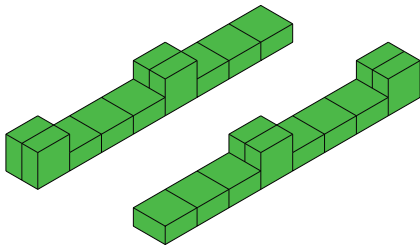

Step 2

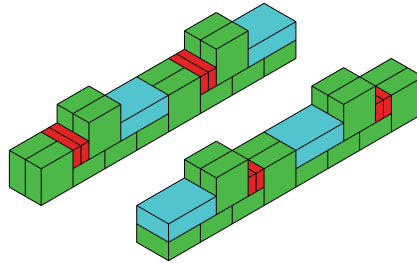

Step 3

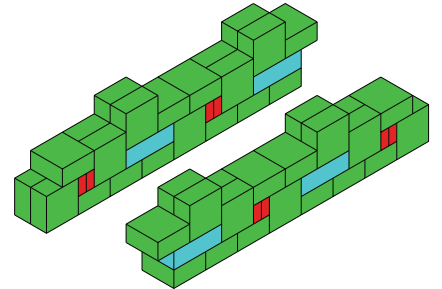

Step 4

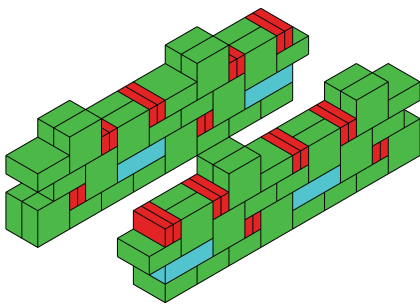

Step 5

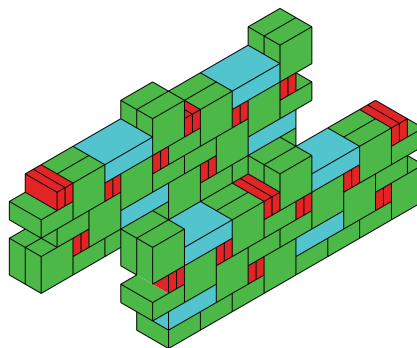

Step 6

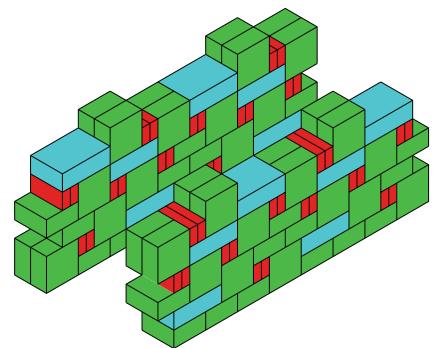

Step 7

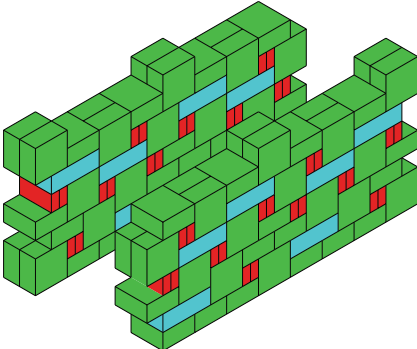

Step 8

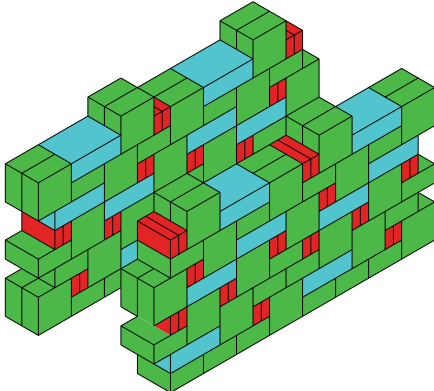

Step 9

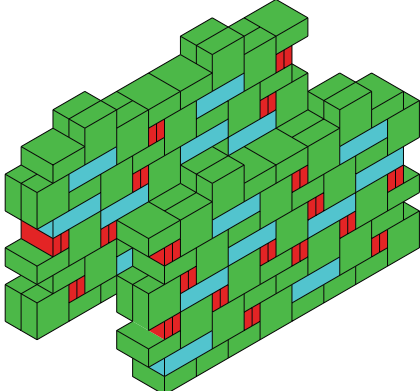

Step 10

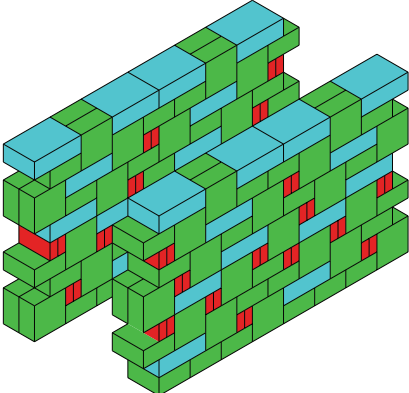

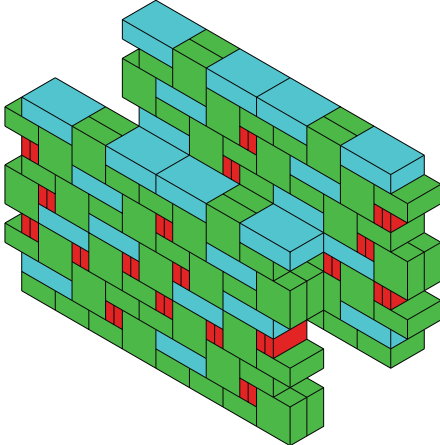

Back View



INSTALLATION INSTRUCTIONS

38.5 Inch Grill Module

NUMBER OF PIECES PER PROJECT:			HOME DEPOT SKU#		
			Café	Sierra Blend	GreyStone
	Mini	30	163156	397745	164917
	Medium	79	165955	397681	166379
	Large	19	166606	396781	166804

- Prepare stable, level project area.
- Stack stones, adding construction adhesive between layers.

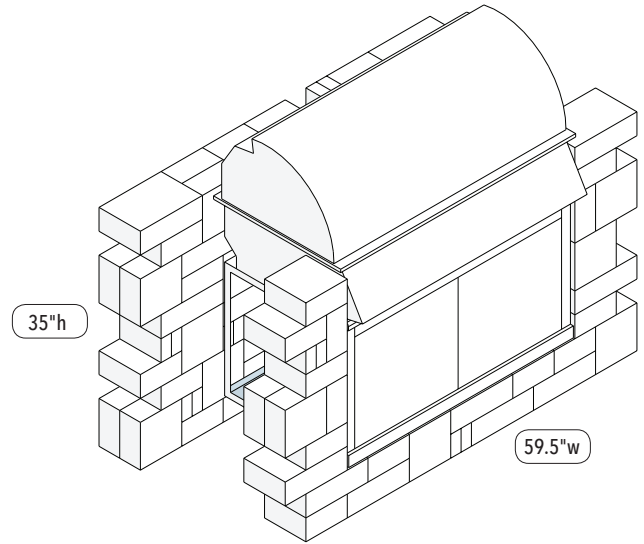

Measurements for projects are approximate.

Step 1

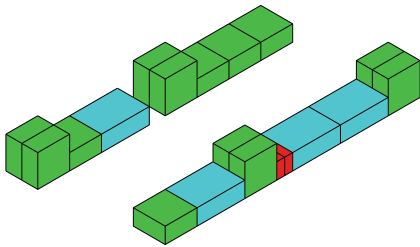

Step 2

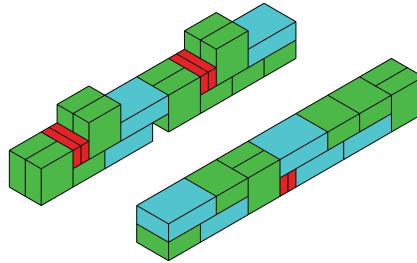

Step 3

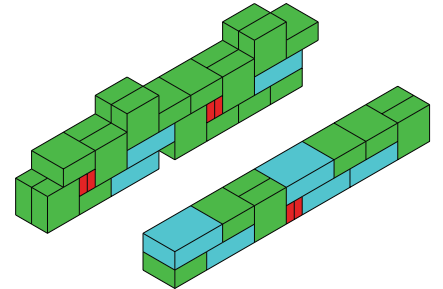

Step 4

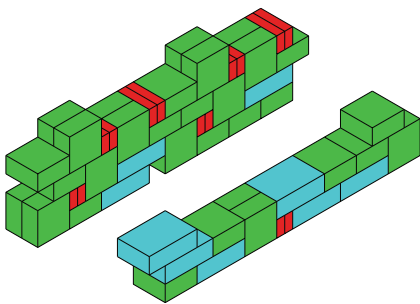

Step 5

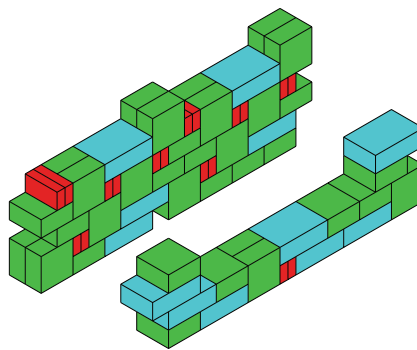

Step 6

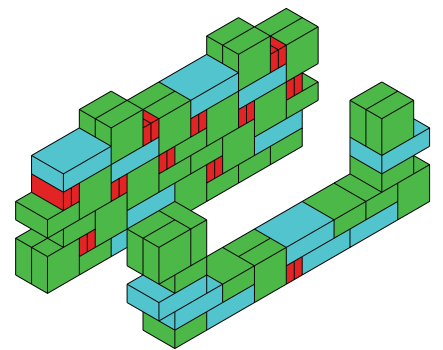

Step 7

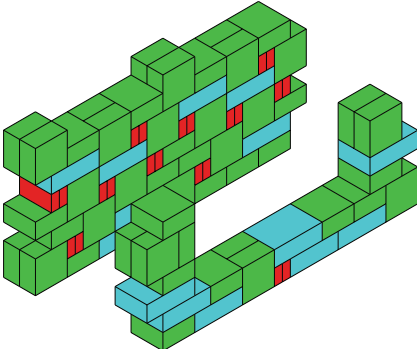

Step 8

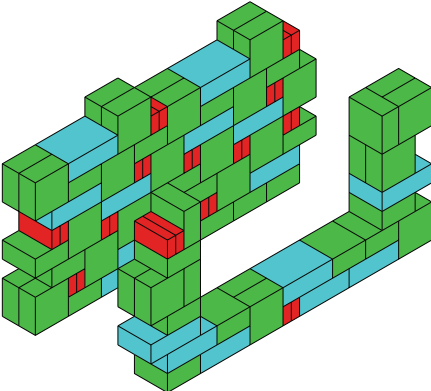

Step 9

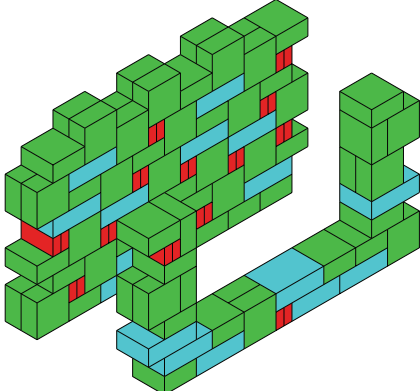

Step 10

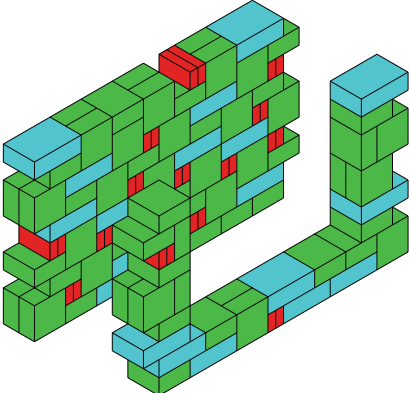

Step 11

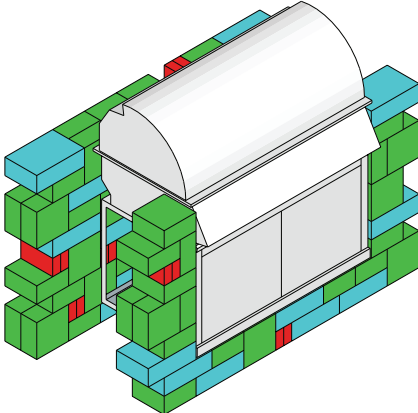

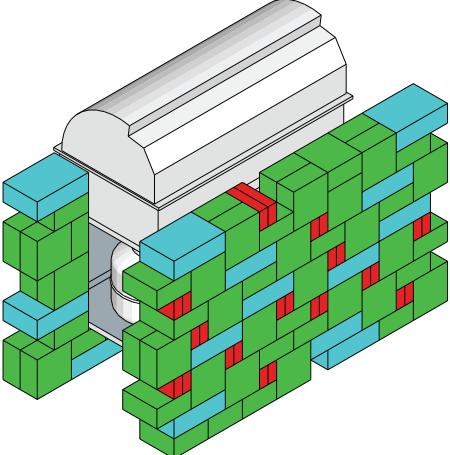

Back View



Note: Plan is only an example and the actual construction must be ad libbed to conform to the selected grill. Contact grill manufacturer for proper venting requirements.

INSTALLATION INSTRUCTIONS

Fridge Module

NUMBER OF PIECES PER PROJECT:			HOME DEPOT SKU#		
			Café	Sierra Blend	GreyStone
	Mini	36	163156	397745	164917
	Medium	88	165955	397681	166379
	Large	22	166606	396781	166804

- Prepare stable, level project area.
- Stack stones, adding construction adhesive between layers.

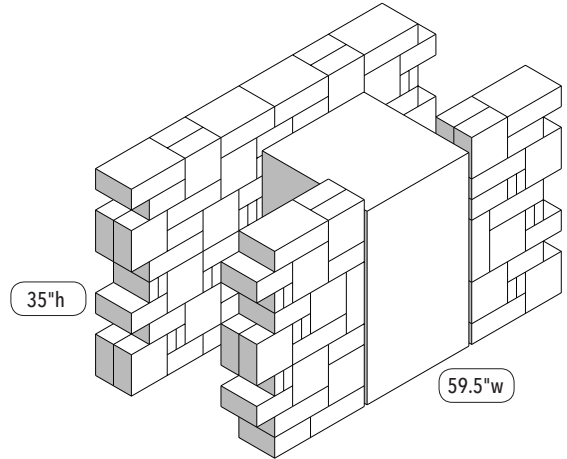

Measurements for projects are approximate.

Step 1

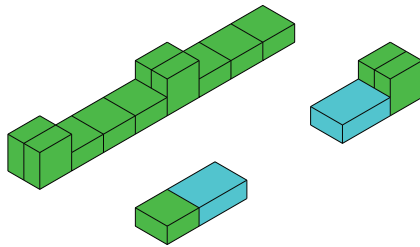

Step 2

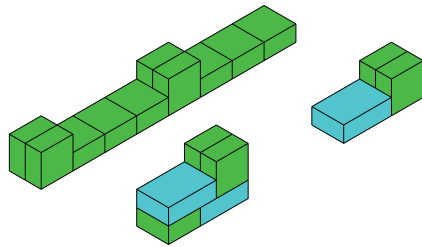

Step 3

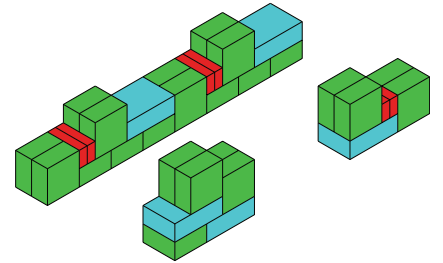

Step 4

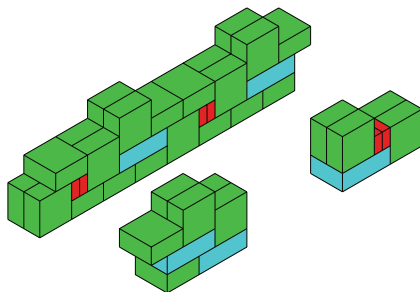

Step 5

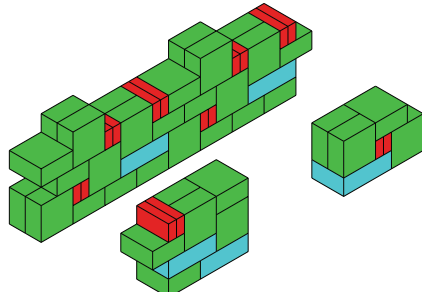

Step 6

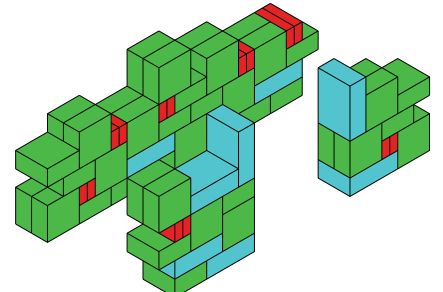

Step 7

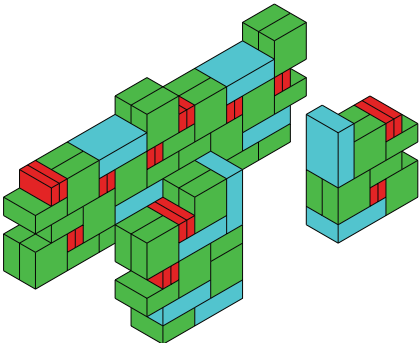

Step 8

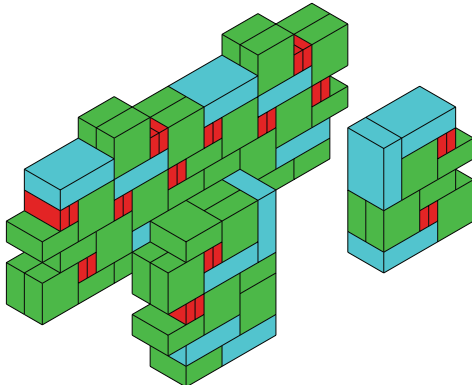

Step 9

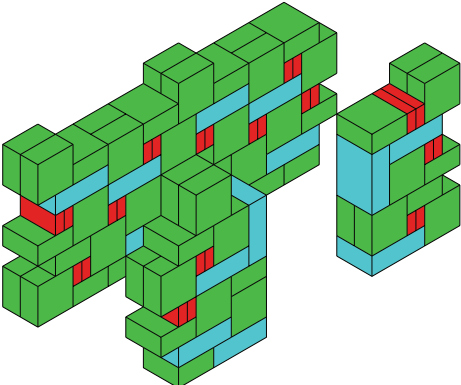

Step 10

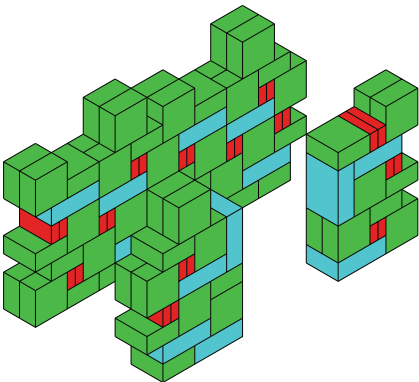

Step 11

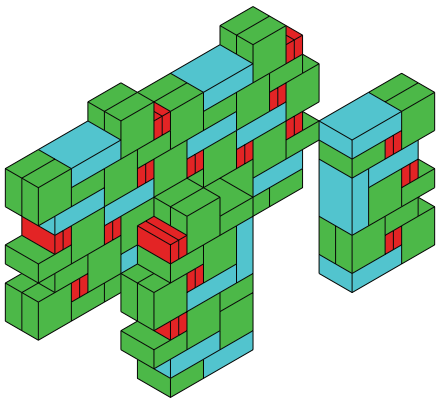

Step 12

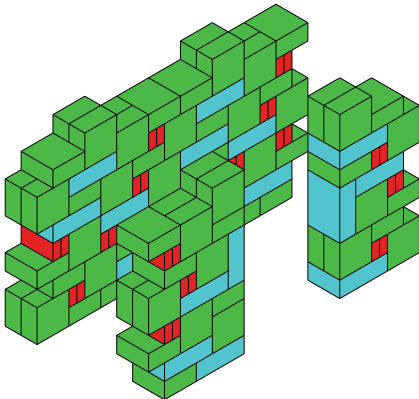

Step 13

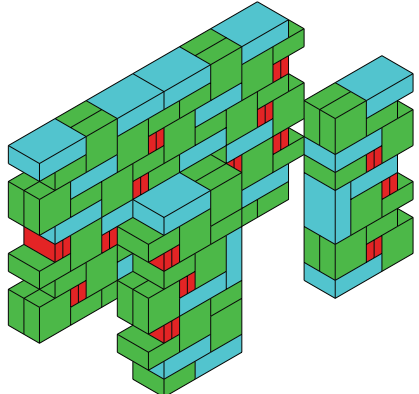

Step 14

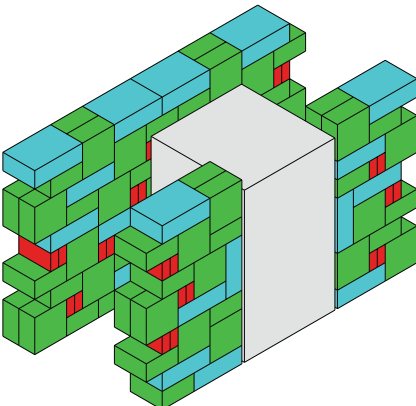

Back View

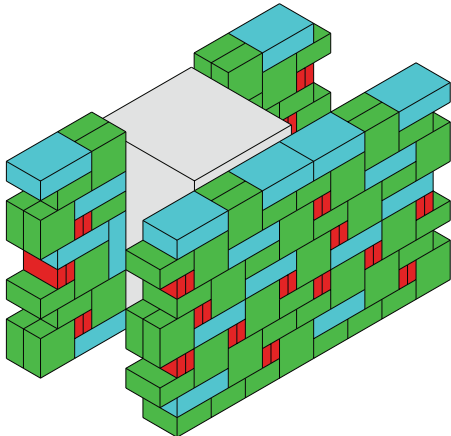

INSTALLATION INSTRUCTIONS

Module Cut Outs

Need help laying out your first course or laying out your project?

Use the cut outs below to help design your RumbleStone Outdoor Kitchen. Cut along RED dotted line.

